

Article number: 20350232943NI

Description: E+G Levelling sets GN 350.2-32-9-43-NI

Measures

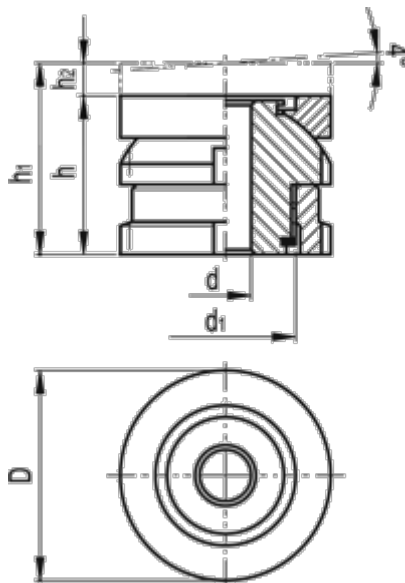

C-spanner DIN 1810 = A30-32

d = 9

D = 32

d_1 = M20x1

For screw = M8

h = 43

h_1 = 63

h_2 = 20

Max static load (kN) = 43.4

Static preload (kN) = 36.56

Weight (g) = 200